

VASMAR

Інструкція
1600052CL-01MG

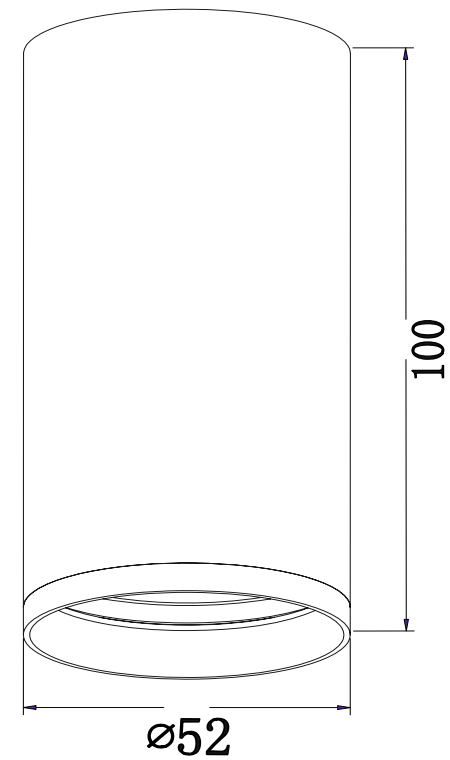
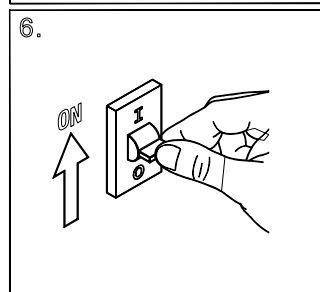
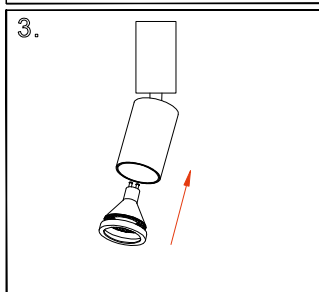
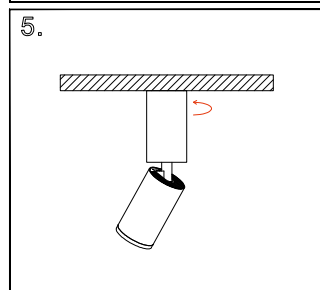
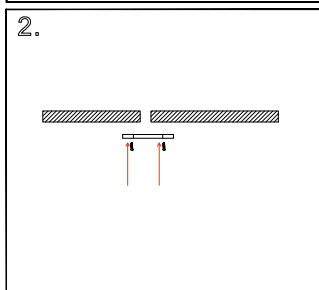
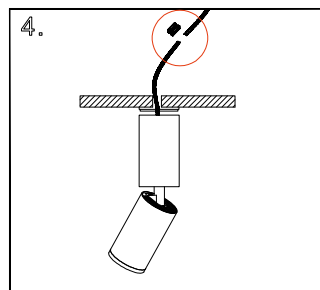
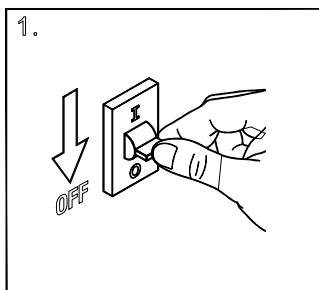

1 x GU10 (10W)