

# VASMAR

Інструкція  
VM5205WL-01BS

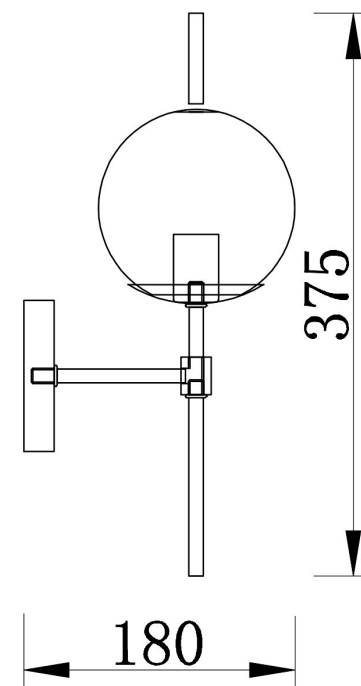
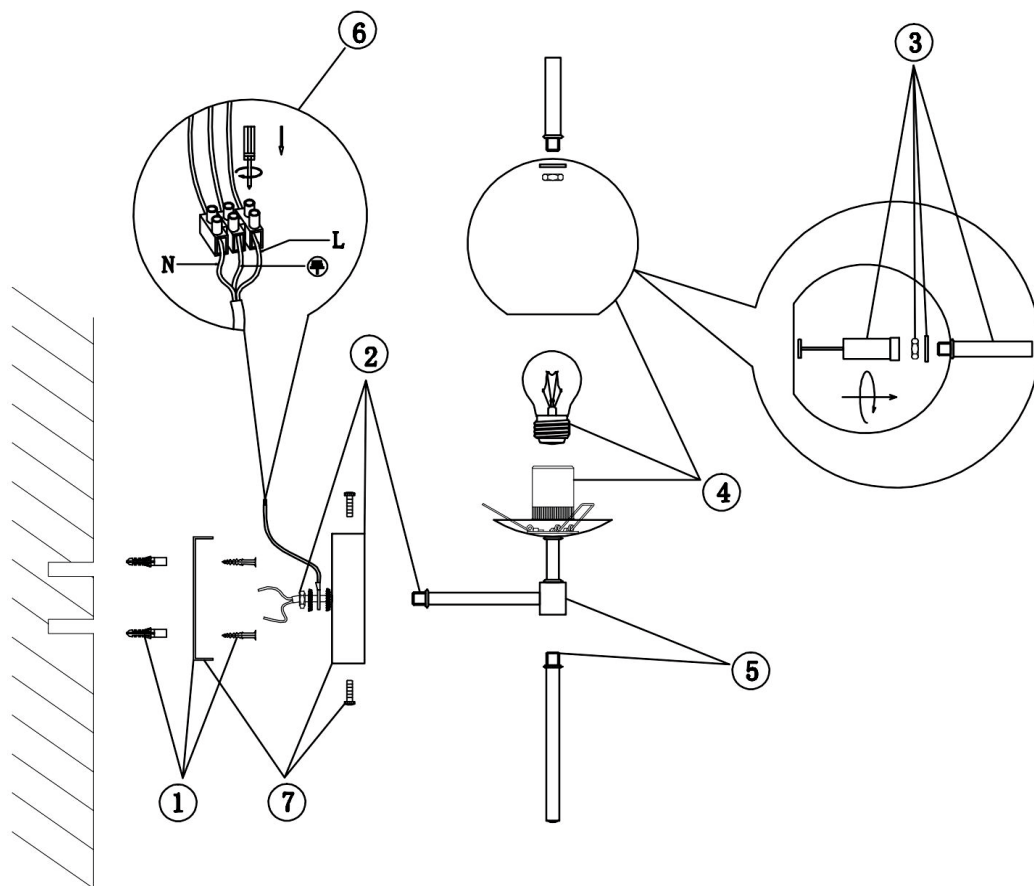

1xE27 60W