

# VASMAR

Інструкція  
VM5214WL-01BS

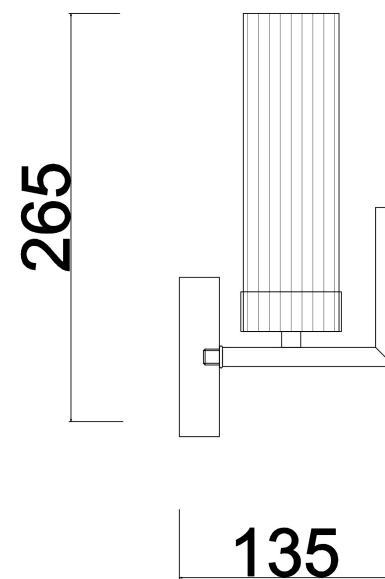
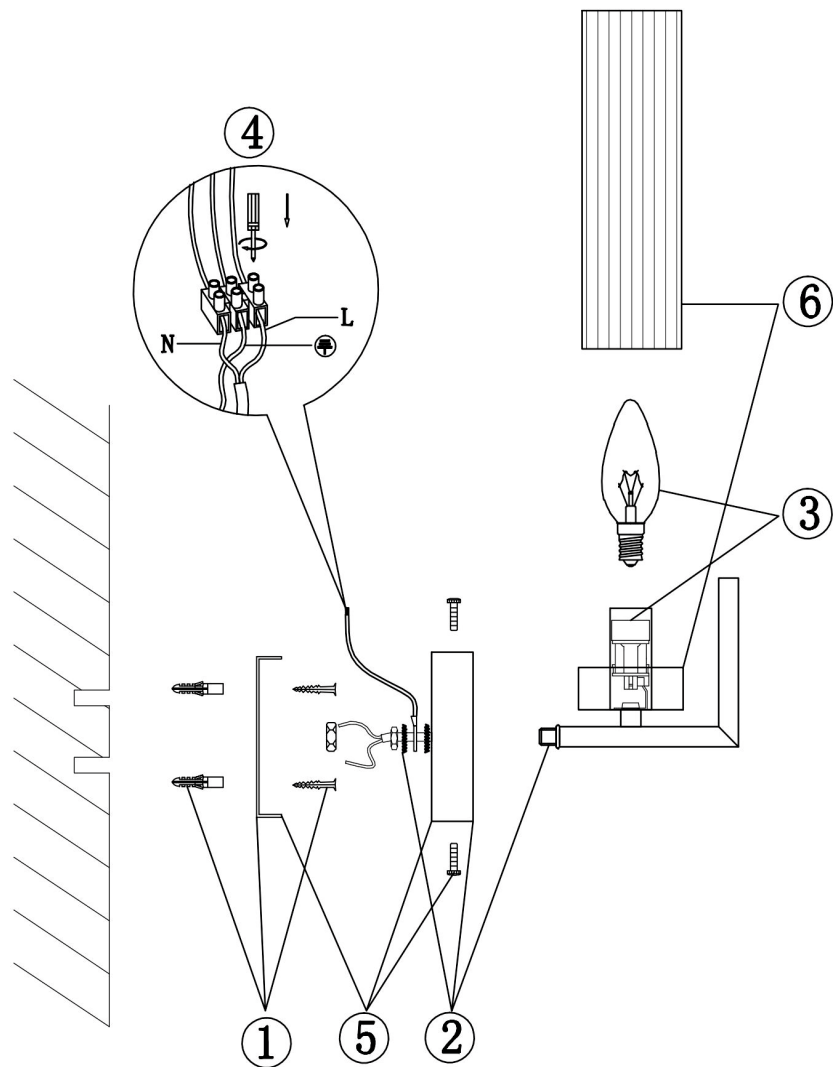

1xE14 60W