

VASMAR

Інструкція
1600016CL-01W

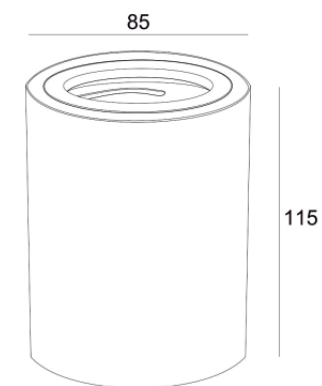
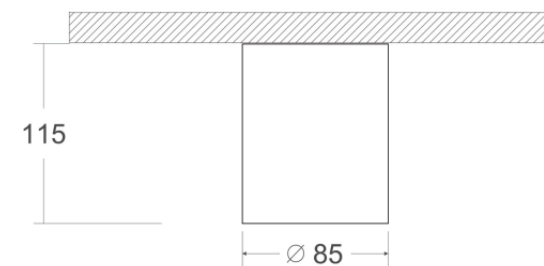
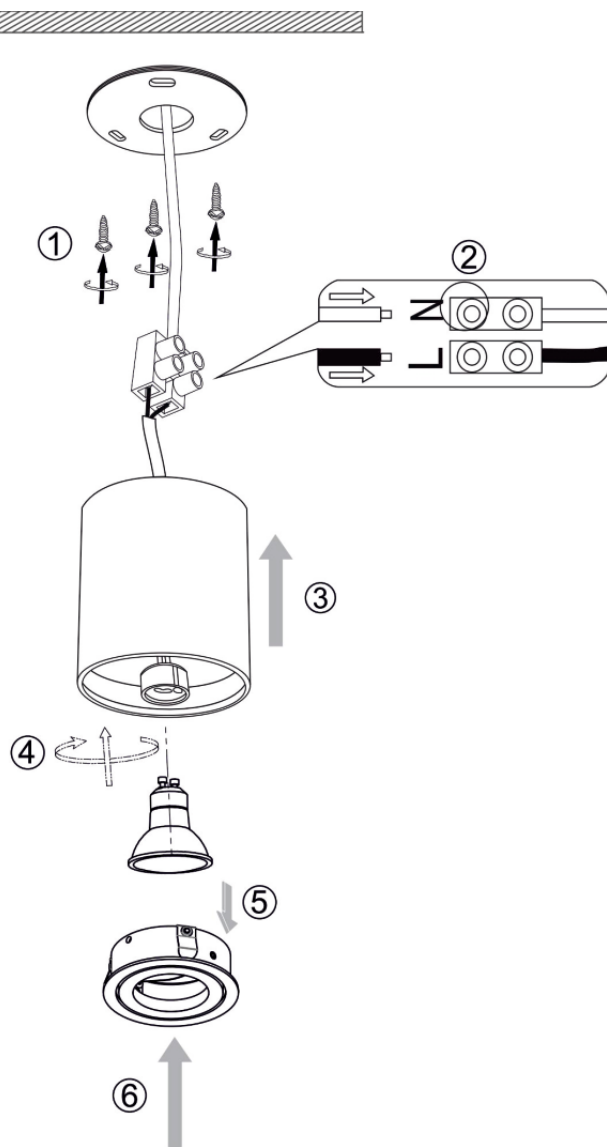

1xGU10 50W